

*Zapsáno / Registered 17/12/2018*

*No 005908688-0001*



**ÚŘAD EVROPSKÉ UNIE PRO DUŠEVNÍ  
VLASTNICTVÍ  
POTVRZENÍ O ZÁPISU DO  
REJSTŘÍKU**

Toto osvědčení o zápisu do rejstříku se vydává pro níže  
uvedený průmyslový vzor Společenství. V rejstříku  
zapsaných průmyslových vzorů Společenství byly  
provedeny odpovídající zápisy.

---

**EUROPEAN UNION INTELLECTUAL  
PROPERTY OFFICE  
CERTIFICATE OF REGISTRATION**

This Certificate of Registration is hereby issued for the  
Registered Community Design identified below. The  
corresponding entries have been recorded in the  
Register of Community Designs.

*Výkonný ředitel / The Executive Director*

*Christian Archambeau*





21	005908688-0001
25	CS - EN
22	17/12/2018
15	17/12/2018
45	04/01/2019
11	005908688-0001
73	SENSE Vital Air, s.r.o. Pod Višňovkou 1661/35 CZ-14000 Praha 4 REPÚBLICA CHECA
74	HARBER IP S.R.O. Na bělidle 64/3, CZ-150 00 Prague 5 - Smíchov REPÚBLICA CHECA
51	23 - 04
54	<b>BG</b> - Уреди за пречистване на въздуха
	<b>ES</b> - Aparatos para la purificación del aire
	<b>CS</b> - Čističky vzduchu
	<b>DA</b> - Luftrensere
	<b>DE</b> - Luftreiniger
	<b>ET</b> - Õhupuhastusseadmed
	<b>EL</b> - Συσκευές καθαρισμού του αέρα
	<b>EN</b> - Air purifiers
	<b>FR</b> - Purificateurs d'air
	<b>IT</b> - Purificatori d'aria
	<b>LV</b> - Gaisa attīrīšanas iekārtas
	<b>LT</b> - Oro valymo įranga
	<b>HR</b> - Pročišćivači zraka
	<b>HU</b> - Légtisztító
	<b>MT</b> - Purifikaturi tal-arja
	<b>NL</b> - Luchtzuiveringsapparaten
	<b>PL</b> - Urządzenia do oczyszczania powietrza
	<b>PT</b> - Purificadores do ar
	<b>RO</b> - Aparate de purificare a aerului
	<b>SK</b> - Zariadenia na čistenie vzduchu
	<b>SL</b> - Čistilne naprave za zrak
	<b>FI</b> - Ilmanpuhdistimet
	<b>SV</b> - Luftrenare
30	-
57	
55	

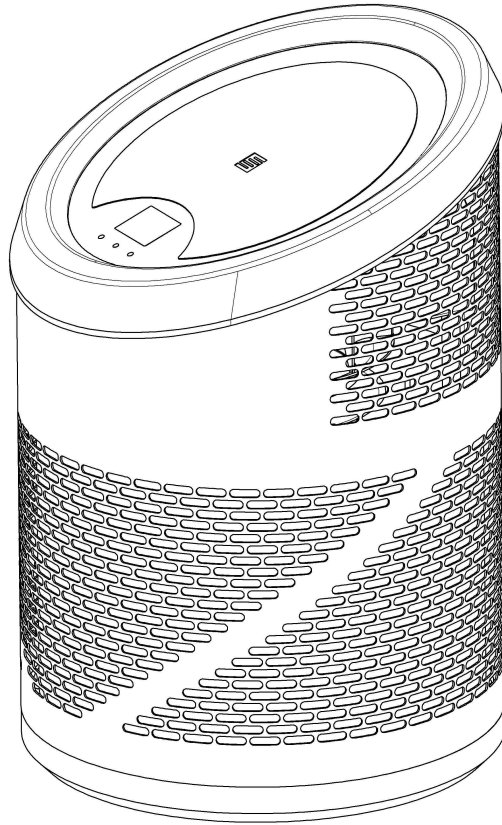

0001.1

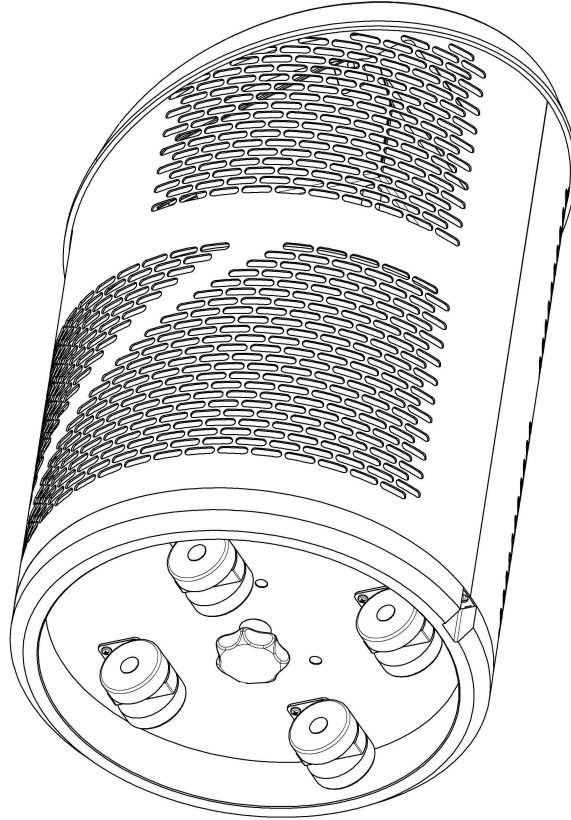

0001.2

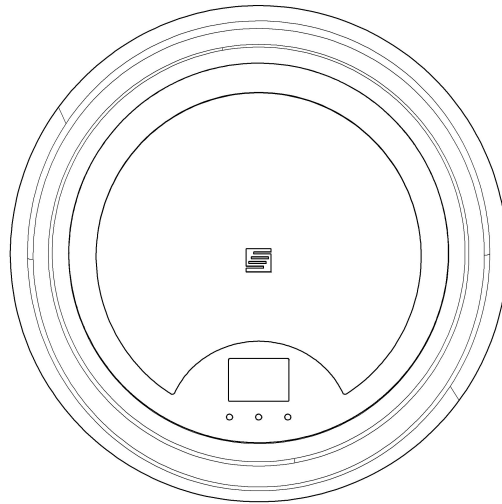

0001.3

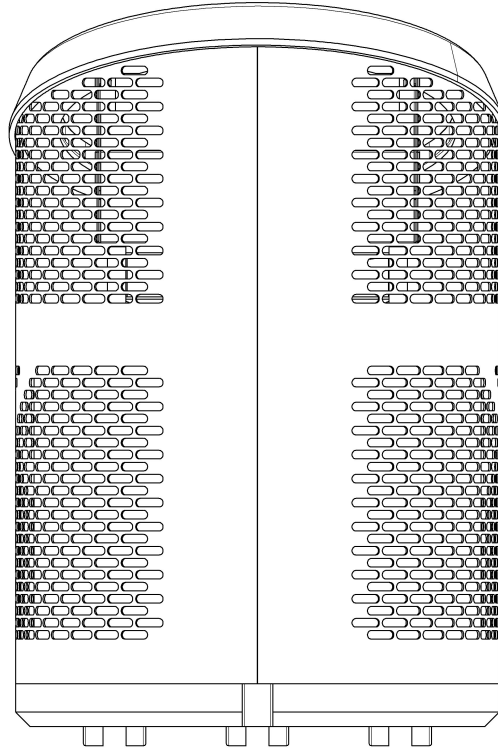

0001.4

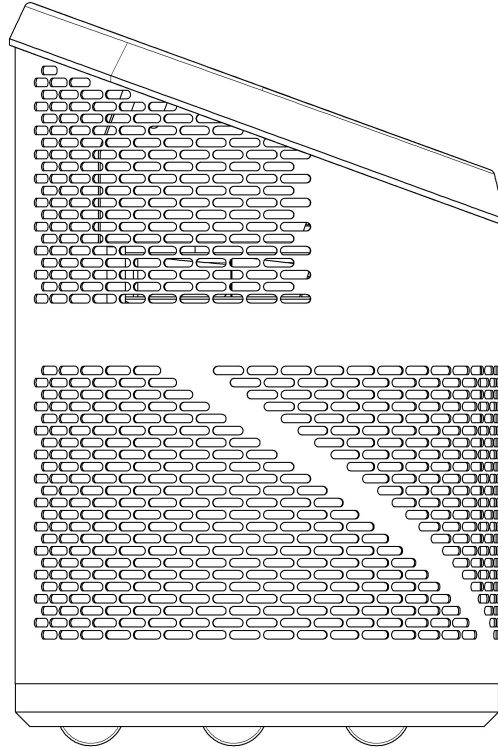

0001.5

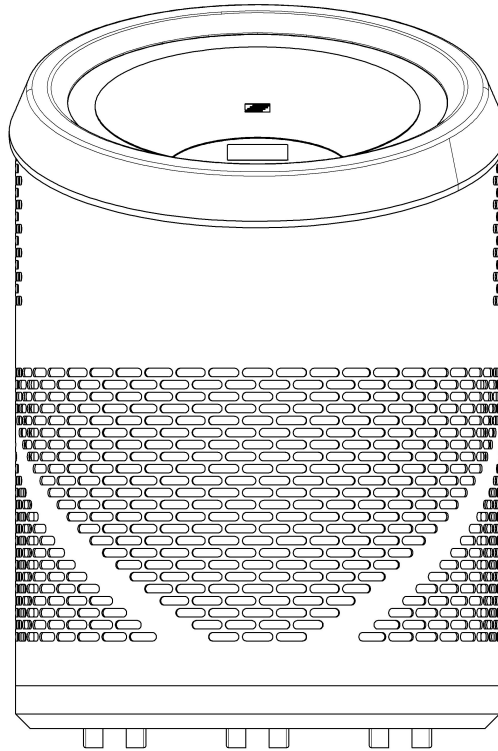

0001.6



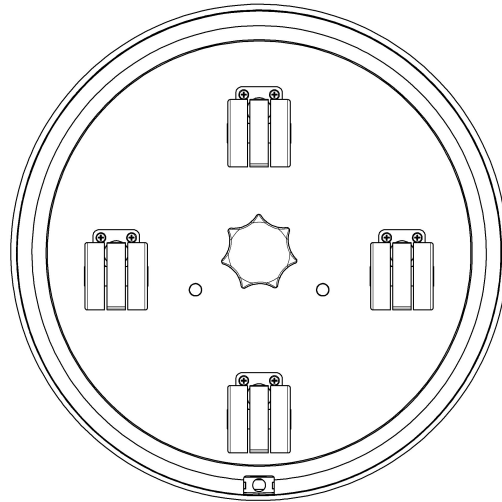

0001.7